

YDS-USB-1879 V2**2.3MP OnSemi AR0234 Global Shutter M12 Fixed Focus USB 2.0 Camera Module**

YDS-USB-1879 V2 is a 2.3MP Fixed Focus USB camera module based on 1/2.6" AR0234 global shutter image sensor. It delivers high-speed, 2K resolution ultra sharp image. The S-mount (M12) lens holder enables customers to choose different lens as per varies applications. This camera module is ideal solution for face recognition, identity detection, automotive, access control.

Key Features

- 2K resolution (1920 x 1200) OnSemi AR0234 sensor
- High speed USB 2.0 Plug and Play
- MJPEG and YUV2 output format
- Low power consumption
- Compact size
- UVC compliant to Windows, Linux, OS with UVC driver
- USB OTG (On-The-Go) support

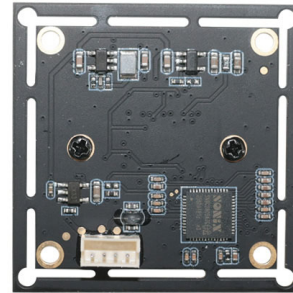

YDS CAMERA MODULE

your best camera partner

YDS-USB-1879 V2

2.3MP OnSemi AR0234 Global Shutter M12 Fixed Focus USB 2.0 Camera Module

Camera Module No.	YDS-USB-1879 V2
Resolution	2.3MP
Image Sensor	AR0234 Global Shutter
Sensor Type	1/2.6"
Pixel Size	3.0 um x 3.0 um
EFL	6.03 mm
F.NO	2.50
Pixel	1920 x 1200
View Angle	32.0°(DFOV) 27.0°(HFOV) 17.0°(VFOV)
Lens Dimensions	17.00 x 17.00 x 22.70 mm
Module Type	Fixed Focus
Interface	USB 2.0
Output Format	MJPEG / YUV2
Auto Control	Saturation, Contrast, Acutance White Balance, Exposure
Audio	Optional
Input Voltage	DC 5V
Working Current	Max 500mA
PCB Size	38.00 x 38.00 / 32.00 x 32.00 mm
System Compatibility	Windows XP (SP2, SP3), Vista, 7, 8, 10, 11 Android, Mac OS, Linux or OS with UVC Driver Raspberry Pi by USB Port
Software for USB Camera	AMCAP, Webcam Viewer, V4L2 Controls Contacam, VLC Player, MotionEye OS iSpy, ZoneMider, Yawcam
Lens Type	650nm IR Cut
Operating Temperature	-30°C to +70°C
USB Cable	USB Cable

Wide Compatibility with Windows, Android, Mac OS, Linux, or Raspberry Pi



www.YDSCAM.com sales@ydscom.com Phone (WeChat, QQ): (+86) 177 2732 6718

All rights reserved @ YingDeShun Co. Ltd. Specifications subject to change without notice.



YDS-USB-1879 V2

2.3MP OnSemi AR0234 Global Shutter M12 Fixed Focus USB 2.0 Camera Module



Top View

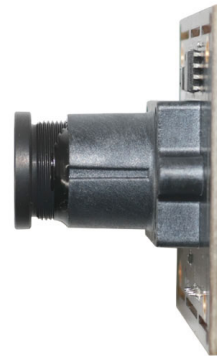

Side View



Bottom View



USB Cable

YDS-USB-1879 V2

2.3MP OnSemi AR0234 Global Shutter M12 Fixed Focus USB 2.0 Camera Module

FORMAT	RESOLUTION	FRAME RATE
		USB 2.0
MJPEG	640 x 480 (VGA)	30 FPS
	1280 x 720 (720P)	30 FPS
	1920 x 1080 (1080P)	30 FPS
YUV2	640 x 480 (VGA)	30 FPS
	1280 x 720 (720P)	10 FPS
	1920 x 1080 (1080P)	5 FPS



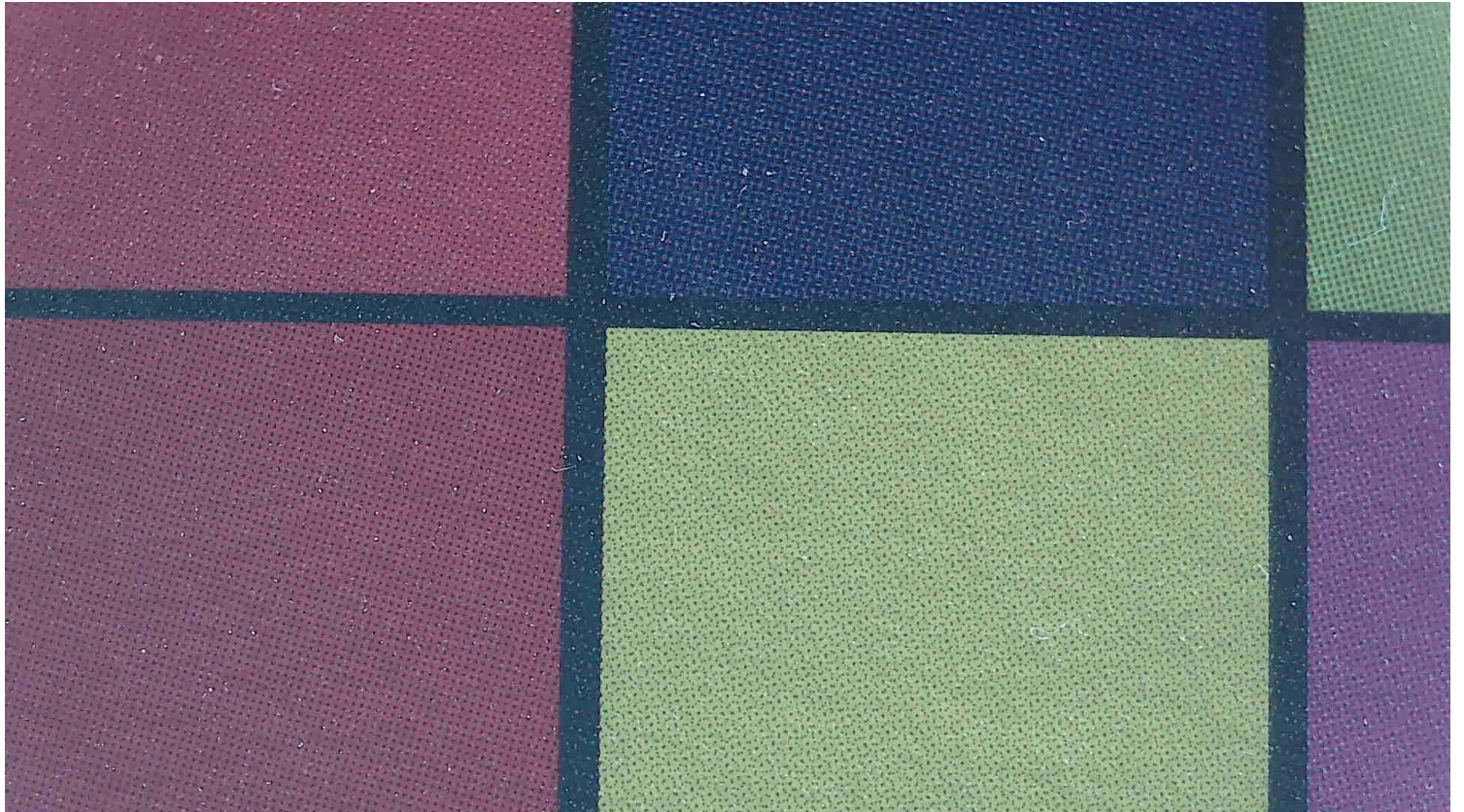
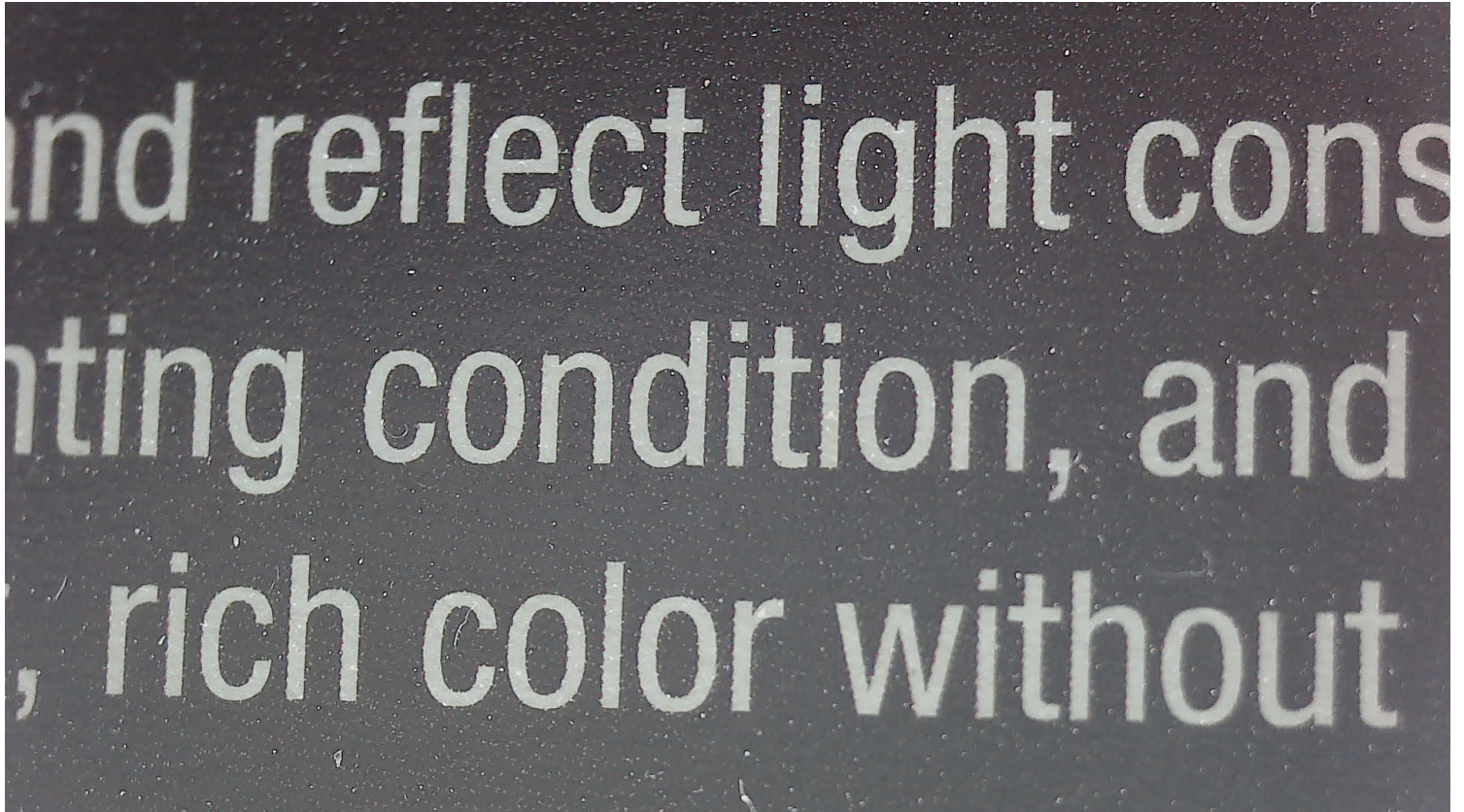



such as sky blue, consistently throughout the with any color reproduction or mixed tints.

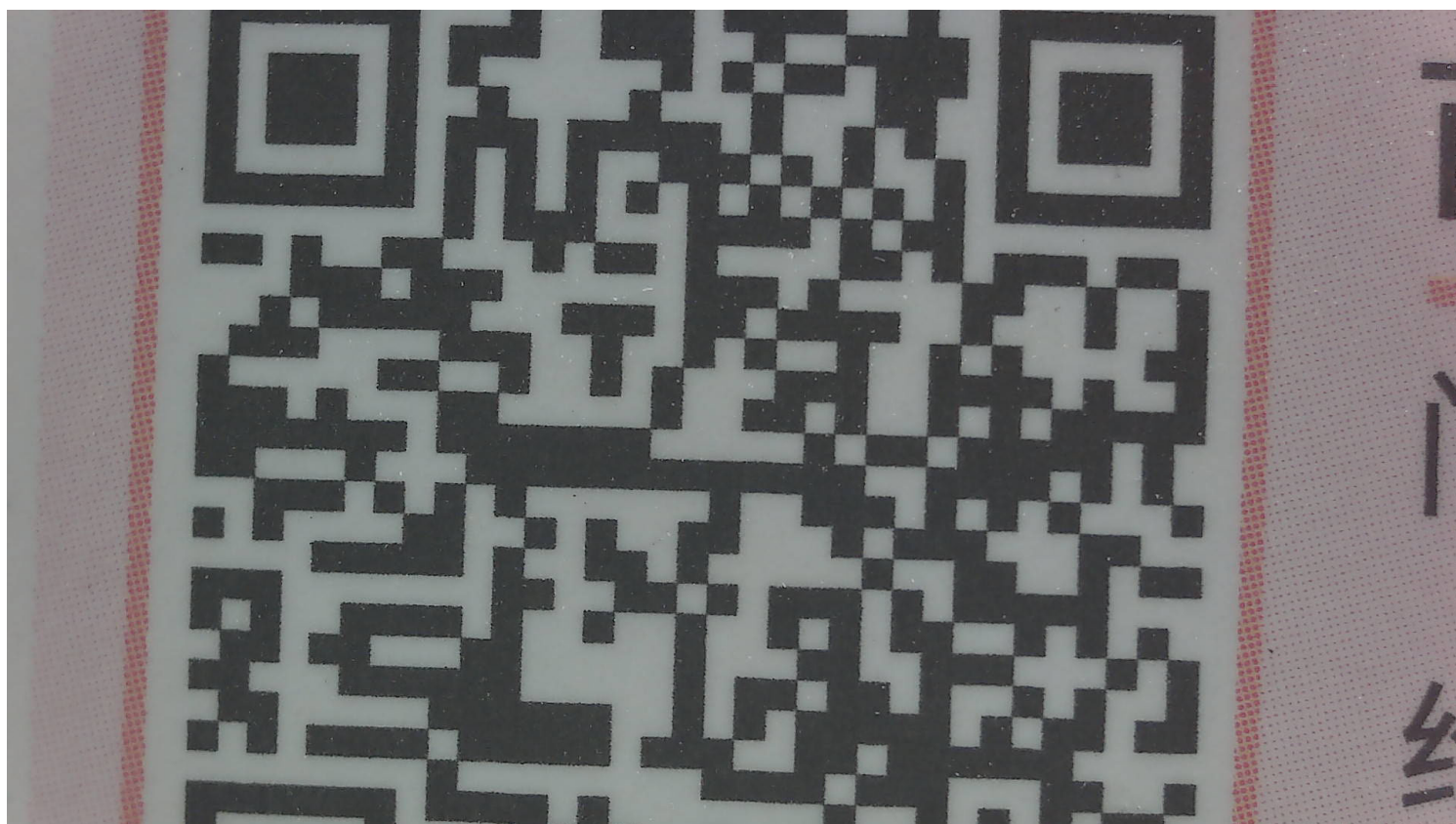



YDS CAMERA MODULE

your best camera partner



www.YDSCAM.com sales@ydscam.com Phone (WeChat, QQ): (+86) 177 2732 6718

All rights reserved @ YingDeShun Co. Ltd. Specifications subject to change without notice.

Version	Information
V1.0	First Version
V2.0	Change lens and holder

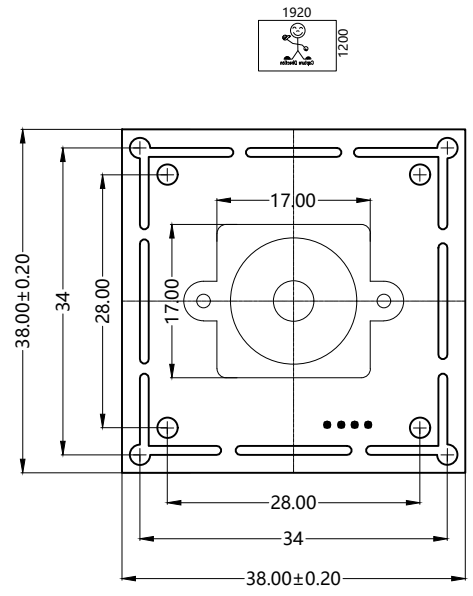

TOP VIEW

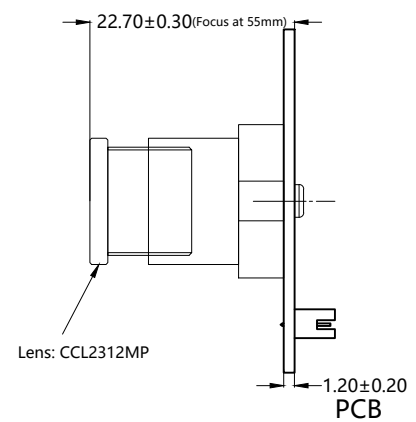

SIDE VIEW

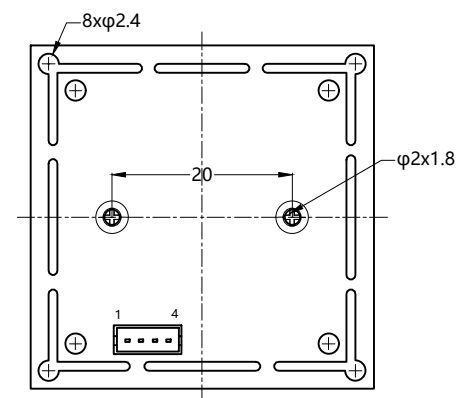

PH1.5,top entry type, 4 PINS

DGND	DP	DM	USB5V
P4	P3	P2	P1

BOTTOM VIEW

Parameter:	
1、 Sensor specification: Image Sensor: AR0234CS Pixel: 3.0um*3.0um Lens Type: 1/2.6 Important Voltage Description: USB 5V	2、 Lens specification: FOV: 32°(D);27°(H);17°(V) F/NO.: 2.8% TV distortion: <-1.5% Focal length: 12mm Composition: 6G+IR FILTER IR Cut Coating: 650nm±10nm@50%

YingDeShun Co. Ltd.

Designed By	Kevin	Model Name:	YDS-USB-1879 V2		
Checked By	Jacky	Projection Type:	Unit: mm	Date: 12/23/2025	
		Third Angle	Scale: 1:1	Sheet: 1 of 1	Version: 1/0

AR0234CS

1/2.6-inch 2.3 Mp CMOS Digital Image Sensor with Global Shutter

Product Overview

For complete documentation, see the data sheet.

The AR0234CS is a 1/2.6-inch 2Mp CMOS digital image sensor with an active-pixel array of 1920 (H) x 1200 (V). It incorporates a new innovative global shutter pixel design optimized for accurate and fast capture of moving scenes at 120 frame per second, full resolution. The sensor produces clear, low noise images in both low-light and bright scenes. It includes sophisticated camera functions such as auto exposure control, windowing, row skip mode, column-skip mode, pixel-binning, and both video and single frame modes. It is programmable through a simple two-wire serial interface. The AR0234CS produces extraordinarily clear, sharp digital pictures with an industry leading Global Shutter Efficiency, and its ability to capture both continuous video and single frames makes it the perfect choice for a wide range of applications, including scanning, autonomous mobility, surveillance and industrial quality control.

Features

- Best in Class Global Shutter Efficiency
- Low Dark Current/Hot Pixels
- High Linear Full Well
- Low Operational Power
- Small Form Factor
- Built-In Statistics Engine
- Multiple Functional Modes - Row & Col Skip Modes, Pixel Binning

Applications

- Gesture recognition
- 3D scanning
- Position tracking
- Machine vision
- AR/VR/MR/XR

































Benefits

- Superior Image Quality for fast-moving objects
- Reduced Total Noise Floor, Higher SNR delivering High Image Fidelity
- High Dynamic Range, delivers higher image clarity
- Suitable of Battery Powered Applications
- Ideal for Space Constrained Applications
- Offloads Image Processor Loads, provides scene details with Prog. ROI
- Application-specific Image Quality Selections with Performance/Power Trade-offs

End Products

- Autonomous Mobile Robots
- Autonomous Guide Vehicles (Drones)
- Video Doorbells
- AR/VR/MR Headsets
- Barcode Readers

Part Electrical Specifications

Product	Pricing (\$/Unit)	Compliance	Status	Type	Megapixels	Frame Rate (fps)	Optical Format	Shutter Type	Pixel Size (µm)	Output Interface	Color	Package Type
AR0234CSSC00SUD20		 	NEW	CMOS	2.3	120	1/2.6 inch	Global Shutter	3.0 x 3.0		Color	
AR0234CSSC00SUKA0-CP		 	Active	CMOS	2.3	120	1/2.6 inch	Global Shutter	3.0 x 3.0		Color	ODCSP-83
AR0234CSSC00SUKA0-CP1		 	Active	CMOS	2.3	120	1/2.6 inch	Global Shutter	3.0 x 3.0		Color	ODCSP-83
AR0234CSSC00SUKA0-CR		 	Active	CMOS	2.3	120	1/2.6 inch	Global Shutter	3.0 x 3.0		Color	ODCSP-83
AR0234CSSC28SUD20		 	NEW	CMOS	2.3	120	1/2.6 inch	Global Shutter	3.0 x 3.0		Color	
AR0234CSSC28SUKA0-CP		 	Active	CMOS	2.3	120	1/2.6 inch	Global Shutter	3.0 x 3.0		Color	ODCSP-83
AR0234CSSC28SUKA0-CP1		 	Active	CMOS	2.3	120	1/2.6 inch	Global Shutter	3.0 x 3.0		Color	ODCSP-83
AR0234CSSC28SUKA0-CR		 	Active	CMOS	2.3	120	1/2.6 inch	Global Shutter	3.0 x 3.0		Color	ODCSP-83
AR0234CSSM00SUD20		 	NEW	CMOS	2.3	120	1/2.6 inch	Global Shutter	3.0 x 3.0		Mono	
AR0234CSSM00SUKA0-CP		 	Active	CMOS	2.3	120	1/2.6 inch	Global Shutter	3.0 x 3.0		Mono	ODCSP-83
AR0234CSSM00SUKA0-CP1		 	Active	CMOS	2.3	120	1/2.6 inch	Global Shutter	3.0 x 3.0		Mono	ODCSP-83
AR0234CSSM00SUKA0-CR		 	Active	CMOS	2.3	120	1/2.6 inch	Global Shutter	3.0 x 3.0		Mono	ODCSP-83
AR0234CSSM28SUD20		 	NEW	CMOS	2.3	120	1/2.6 inch	Global Shutter	3.0 x 3.0		Mono	
AR0234CSSM28SUKA0-CP		 	Active	CMOS	2.3	120	1/2.6 inch	Global Shutter	3.0 x 3.0		Mono	ODCSP-83
AR0234CSSM28SUKA0-CP1		 	Active	CMOS	2.3	120	1/2.6 inch	Global Shutter	3.0 x 3.0		Mono	ODCSP-83
AR0234CSSM28SUKA0-CR		 	Active	CMOS	2.3	120	1/2.6 inch	Global Shutter	3.0 x 3.0		Mono	ODCSP-83

Cameras Applications



Automotive Driver Pilot



Live Streaming



Video Conference



Eye Tracker Biometric Detection

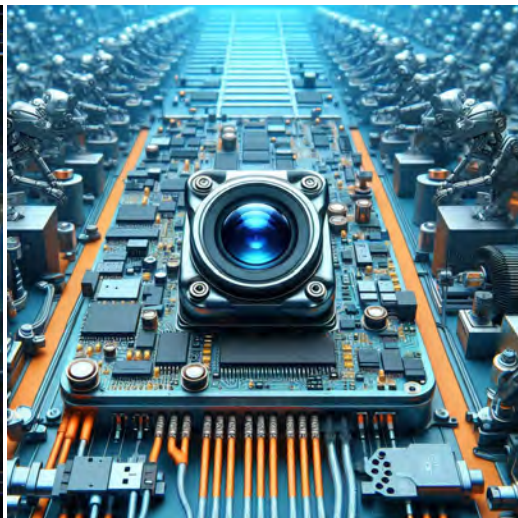

Machine Vision



Agricultural Monitor



Night Vision Security



Drone and Sports Eagle Eyes



Interactive Pet Camera



YDS CAMERA MODULE

your best camera partner

Camera Module Pinout Definition Reference Chart

OmniVision	Sony	Samsung	On-Semi	Aptina	Himax	GalaxyCore	PixArt	SmartSens	Sensors
Pin Signal		Description							
DGND GND		ground for digital circuit							
AGND		ground for analog circuit							
PCLK DCK		DVP PCLK output							
XCLR PWDN XSHUTDOWN STANDBY		power down active high with internal pull-down resistor							
MCLK XVCLK XCLK INCK		system input clock							
RESET RST		reset active low with internal pull-up resistor							
NC NULL		no connect							
SDA SIO_D SIOD		SCCB data							
SCL SIO_C SIOC		SCCB input clock							
VSYNC XVS FSYNC		DVP VSYNC output							
HREF XHS		DVP HREF output							
DOVDD		power for I/O circuit							
AFVDD		power for VCM circuit							
AVDD		power for analog circuit							
DVDD		power for digital circuit							
STROBE FSTROBE		strobe output							
FSIN		synchronize the VSYNC signal from the other sensor							
SID		SCCB last bit ID input							
ILPWM		mechanical shutter output indicator							
FREQ		frame exposure / mechanical shutter							
GPIO		general purpose inputs							
SLASEL		I2C slave address select							
AFEN		CEN chip enable active high on VCM driver IC							
MIPI Interface									
MDN0 DN0 MD0N DATA_N DMO1N		MIPI 1st data lane negative output							
MDP0 DP0 MD0P DATA_P DMO1P		MIPI 1st data lane positive output							
MDN1 DN1 MD1N DATA2_N DMO2N		MIPI 2nd data lane negative output							
MDP1 DP1 MD1P DATA2_P DMO2P		MIPI 2nd data lane positive output							
MDN2 DN2 MD2N DATA3_N DMO3N		MIPI 3rd data lane negative output							
MDP2 DP2 MD2P DATA3_P DMO3P		MIPI 3rd data lane positive output							
MDN3 DN3 MD3N DATA4_N DMO4N		MIPI 4th data lane negative output							
MDP3 DP3 MD3P DATA4_P DMO4P		MIPI 4th data lane positive output							
MCN CLKN CLK_N DCKN		MIPI clock negative output							
MCP CLKP MCP CLK_P DCKN		MIPI clock positive output							
DVP Parallel Interface									
D0 DO0 Y0		DVP data output port 0							
D1 DO1 Y1		DVP data output port 1							
D2 DO2 Y2		DVP data output port 2							
D3 DO3 Y3		DVP data output port 3							
D4 DO4 Y4		DVP data output port 4							
D5 DO5 Y5		DVP data output port 5							
D6 DO6 Y6		DVP data output port 6							
D7 DO7 Y7		DVP data output port 7							
D8 DO8 Y8		DVP data output port 8							
D9 DO9 Y9		DVP data output port 9							
D10 DO10 Y10		DVP data output port 10							
D11 DO11 Y11		DVP data output port 11							

www.YDSCAM.com sales@ydscam.com Phone (WeChat, QQ): (+86) 177 2732 6718

All rights reserved @ YingDeShun Co. Ltd. Specifications subject to change without notice.

Camera Reliability Test

Reliability Inspection Item		Testing Method	Acceptance Criteria	
Category	Item			
Environmental	Storage Temperature	High 60°C 96 Hours	Temperature Chamber	No Abnormal Situation
		Low -20°C 96 Hours	Temperature Chamber	No Abnormal Situation
	Operation Temperature	High 60°C 24 Hours	Temperature Chamber	No Abnormal Situation
		Low -20°C 24 Hours	Temperature Chamber	No Abnormal Situation
	Humidity	60°C 80% 24 Hours	Temperature Chamber	No Abnormal Situation
	Thermal Shock	High 60°C 0.5 Hours Low -20°C 0.5 Hours Cycling in 24 Hours	Temperature Chamber	No Abnormal Situation
Physical	Drop Test (Free Falling)	Without Package 60cm	10 Times on Wood Floor	Electrically Functional
		With Package 60cm	10 Times on Wood Floor	Electrically Functional
	Vibration Test	50Hz X-Axis 2mm 30min	Vibration Table	Electrically Functional
		50Hz Y-Axis 2mm 30min	Vibration Table	Electrically Functional
		50Hz Z-Axis 2mm 30min	Vibration Table	Electrically Functional
	Cable Tensile Strength Test	Loading Weight 4 kg 60 Seconds Cycling in 24 Hours	Tensile Testing Machine	Electrically Functional
Electrical	ESD Test	Contact Discharge 2 KV	ESD Testing Machine	Electrically Functional
		Air Discharge 4 KV	ESD Testing Machine	Electrically Functional
	Aging Test	On/Off 30 Seconds Cycling in 24 Hours	Power Switch	Electrically Functional
	USB Connector	On/Off 250 Times	Plug and Unplug	Electrically Functional



Camera Inspection Standard

Inspection Item		Inspection Method	Standard of Inspection	
Category	Item			
Appearance	FPC/ PCB	Color	The Naked Eye	Major Difference is Not Allowed.
		Be Torn/Chopped	The Naked Eye	Copper Crack Exposure is Not Allowed.
		Marking	The Naked Eye	Clear, Recognizable (Within 30cm Distance)
	Holder	Scratches	The Naked Eye	The Inside Crack Exposure is Not Allowed
		Gap	The Naked Eye	Meet the Height Standard
		Screw	The Naked Eye	Make Sure Screws Are Presented (If Any)
		Damage	The Naked Eye	The Inside Crack Exposure is Not Allowed
	Lens	Scratch	The Naked Eye	No Effect On Resolution Standard
		Contamination	The Naked Eye	No Effect On Resolution Standard
		Oil Film	The Naked Eye	No Effect On Resolution Standard
		Cover Tape	The Naked Eye	No Issue On Appearance.
	Function	Image	No Communication	Test Board
Bright Pixel			Black Board	Not Allowed In the Image Center
Dark Pixel			White board	Not Allowed In the Image Center
Blurry			The Naked Eye	Not Allowed
No Image			The Naked Eye	Not Allowed
Vertical Line			The Naked Eye	Not Allowed
Horizontal Line			The Naked Eye	Not Allowed
Light Leakage			The Naked Eye	Not Allowed
Blinking Image			The Naked Eye	Not Allowed
Bruise			Inspection Jig	Not Allowed
Resolution			Chart	Follows Outgoing Inspection Chart Standard
Color			The Naked Eye	No Issue
Noise			The Naked Eye	Not Allowed
Corner Dark			The Naked Eye	Less Than 100px By 100px
Color Resolution			The Naked Eye	No Issue
Dimension	Height	The Naked Eye	Follows Approval Data Sheet	
	Width	The Naked Eye	Follows Approval Data Sheet	
	Length	The Naked Eye	Follows Approval Data Sheet	
	Overall	The Naked Eye	Follows Approval Data Sheet	

YDSCAM Package Solutions

YDS Camera Module



Complete with Lens Protection Film

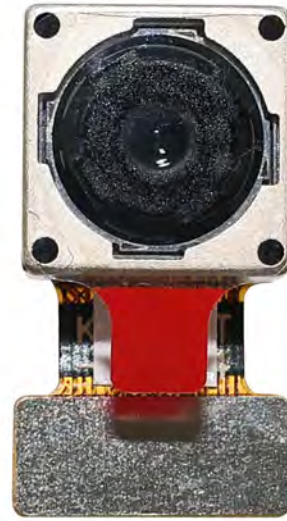

Tray with Grid and Space



Place Cameras on the Tray

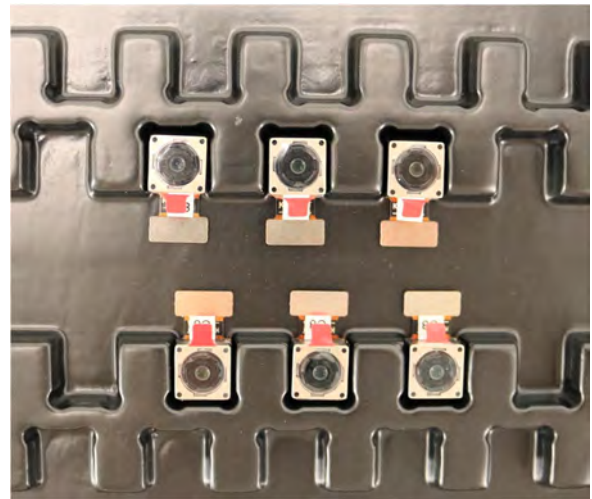

YDSCAM Package Solutions

Full Tray of Cameras

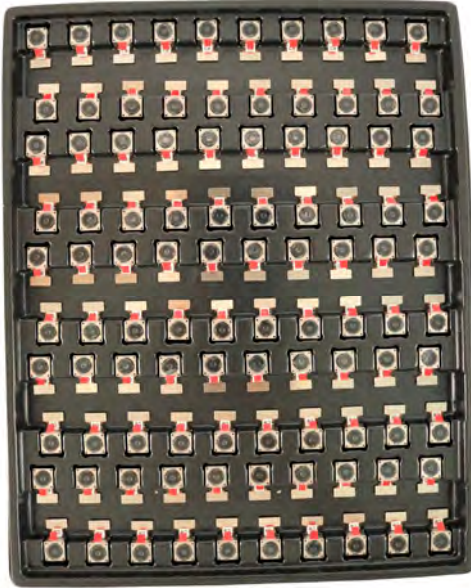

Cover Tray with Lid

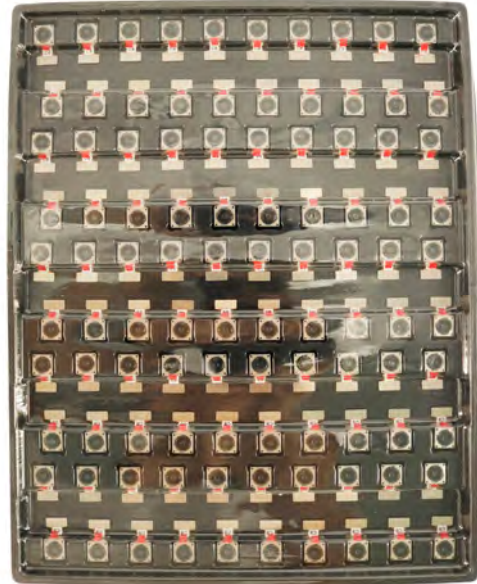

Place Tray into Anti-Static Bag



Vacuum the Anti-Static Bag



YDSCAM Package Solutions

Sealed Vacuum Anti-Static Bag with Labels

1. Model and Description 2. Quantity 3. Manufacturing Date Code 4. Caution



YDSCAM Package Solutions

Place Foam Sheets Between Tray Bags



Foam Sheets are Larger Than Trays



Place Foam Sheets and Trays into Box



Foam Sheets are Tightly Fitting in Box



Seal the Carbon Box



Label the Carbon Shipping Box





YDSCAM Package Solutions

USB Camera Module

Complete with Lens Protection Film

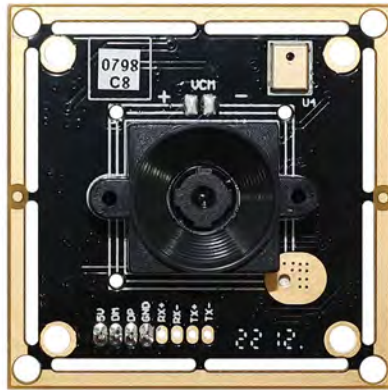

Place Camera Sample into Anti-Static Bag

Place USB Cameras into Tray



Seal the Tray with Anti-Static Bag

Label the Carbon Shipping Box



YDSCAM Package Solutions

Place Camera Sample into Anti-Static Bag



Place Connectors into Anti-Static Bag



Label the Sample Bags



Place Connectors into Reel



Place Samples into the Carbon Box



Place Connectors into the Carbon Box





YDS CAMERA MODULE

your best camera partner

Company YDSCAM

YingDeShun Co. Ltd. (YDS) was established in 2017, a next-generation technology driven manufacturer specialized in research, design, and produce of audio and video products. YDS is occupying 20,000 square feet automated plants with 100 employees of annual throughput 30,000,000 units cameras.

YDS provides OEM, ODM design, contract manufacturing, and builds the camera products. You may provide the requirements to us, even with a hand draft, our sales and engineering work together to meet your needs. We consider ourselves your last-term partner in developing practical and innovative solutions.

Our team covers everything from initial concept development to mass produced product. YDS specializes in customized camera design, raw material, electronic engineering, firmware/software development, product testing, and packing design. Our experienced strategic supply systems offer a robust and dependable manufacturing capacity for orders of various sizes.

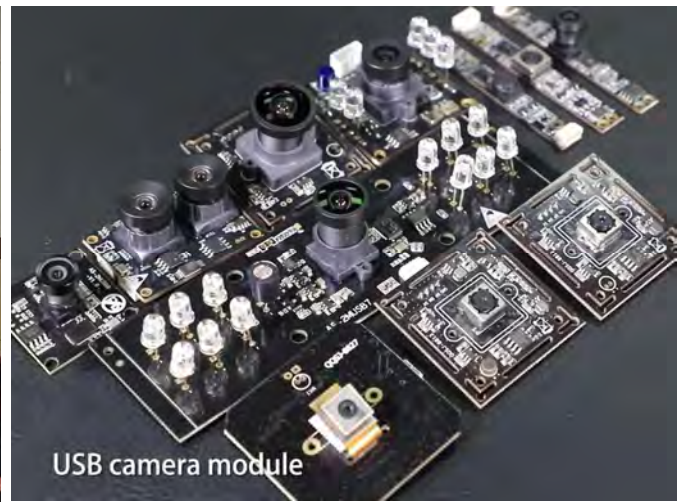

Limited Warranty

YDS provides the following limited warranty if you purchased the Product(s) directly from YDS company or from YDS's website www.YDSCAM.com. Product(s) purchased from other sellers or sources are not covered by this Limited Warranty. YDS guarantees that the Product(s) will be free from defects in materials and workmanship under normal use for a period of one (1) year from the date you receive the product ("Warranty Period").

For all Product(s) that contain or develop material defects in materials or workmanship during the Warranty Period, YDS will, at its sole option, either: (i) repair the Product(s); (ii) replace the Product(s) with a new or refurbished Product(s) (replacement Product(s) being of identical model or functional equivalent); or (iii) provide you a refund of the price you paid for the Product(s).

This Limited Warranty of YDS is solely limited to repair and/or replacement on the terms set forth above. YDS is not reliable or responsible for any subsequent events.



www.YDSCAM.com sales@ydscam.com Phone (WeChat, QQ): (+86) 177 2732 6718

All rights reserved @ YingDeShun Co. Ltd. Specifications subject to change without notice.



YDS CAMERA MODULE

your best camera partner

YDS Strength

Powerful Factory



Professional Service



Promised Delivery



www.YDSCAM.com sales@ydscam.com Phone (WeChat, QQ): (+86) 177 2732 6718

All rights reserved @ YingDeShun Co. Ltd. Specifications subject to change without notice.